



Moderne Licht-Technik AG  
Tägerhardstrasse 110  
5430 Wettingen

056 427 02 50  
info@mlt-licht.ch  
www.mlt-licht.ch

*Gutes Licht  
ist kein Zufall*

A large graphic background featuring a series of parallel, slightly curved lines that create a sense of depth and light rays. The lines are in shades of blue and white, with a soft glow. A large, solid blue triangle is positioned on the left side of the page, pointing towards the center.

## SORTIMENTSÜBERSICHT

*Gutes Licht  
ist kein Zufall*

FÜR ALUMINIUM-  
MONTAGEPROFILE

## ALUMINIUM-MONTAGEPROFILE | AUF EINEN BLICK

### GARLIANO

19 × 22 mm

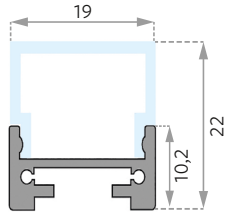

### GARGANO

17,92 × 15,5 mm

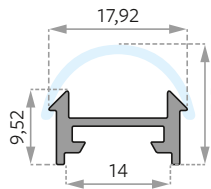

### LP-U2020

20 × 20 mm

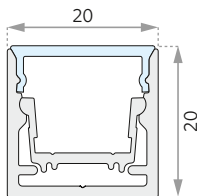

### SMALL WING

24,9–18,8 × 13 mm

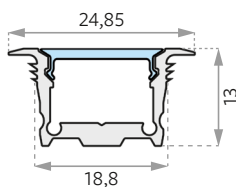

### SMALL CORNER

22,8 × 22,8 mm

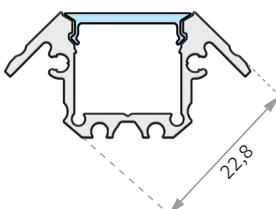

### BARDOLINO H-PROFIL

18,4 × 30 mm

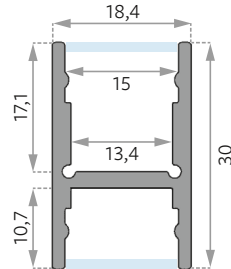

### BARDOLINO DUO

16,6 × 51 mm

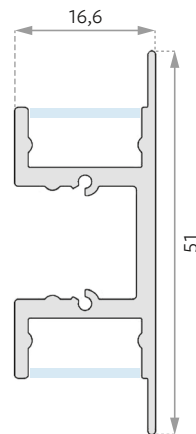

### MEDIUM SQUARE

27 × 23,8 mm

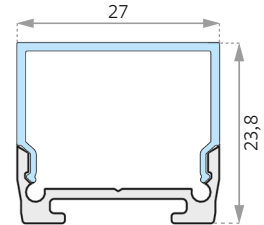

### MEDIUM FLAT

27 × 10,2 mm

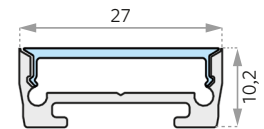

### MEDIUM U

27 × 25,9 mm

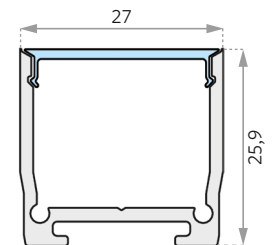

### MEDIUM WING

40–27 × 25,9 mm

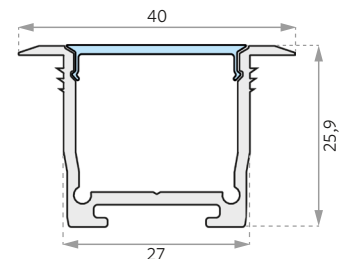

### SMALL FLAT

17,3 × 9,6 mm

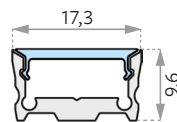

### SMALL U

17,3 × 16 mm

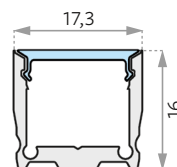

## ALUMINIUM-MONTAGEPROFILE | AUF EINEN BLICK

LP-U3030  
30×30 mm

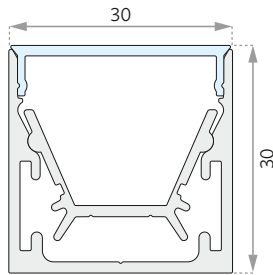

ANGOLO ECK-PROFIL  
30×30 mm

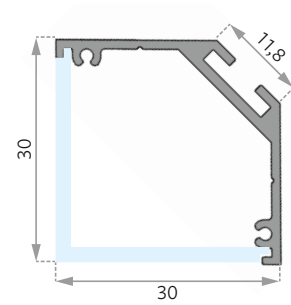

EPIC III  
39,5×62,8 mm

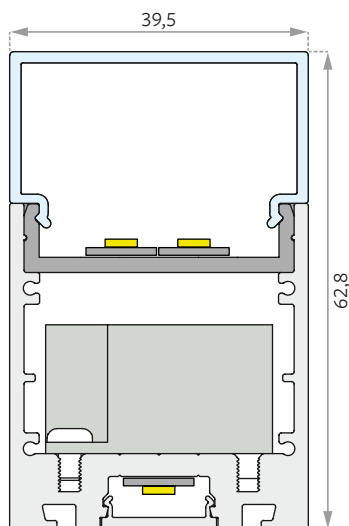

LP-U5050  
50×50 mm

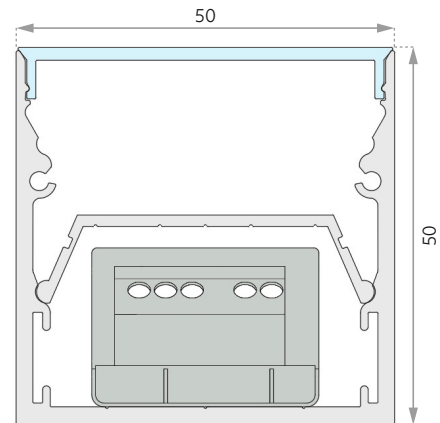

## EINLEGE- UND GRUNDPROFILE | FÜR SICHTBETON/WEISSPUTZ (VARIABLE LÄNGEN)

VISTO 30

Konverter extern

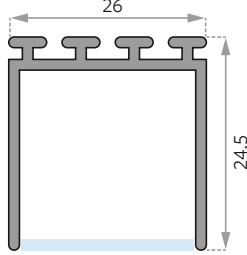
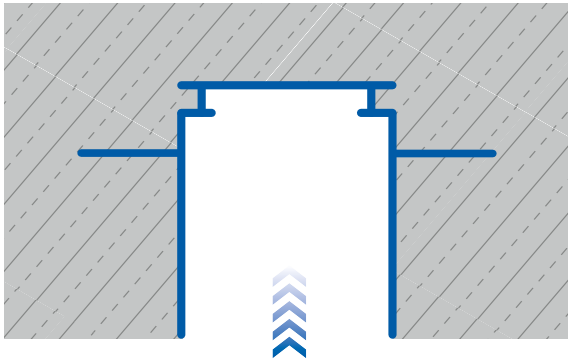

**LIPOD** 26×24,5 mm

PRIMO 30

Konverter extern

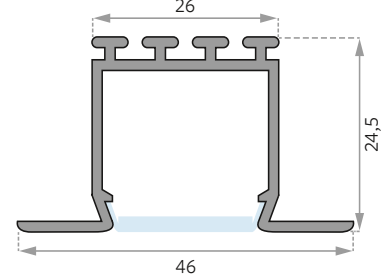
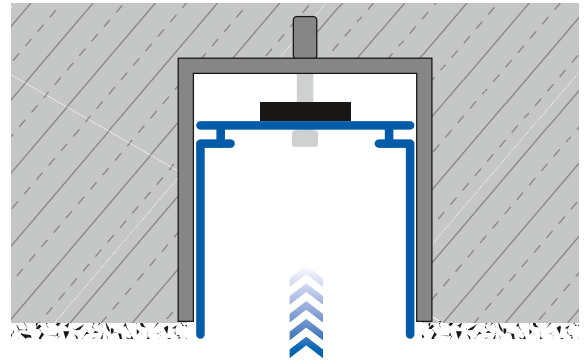

**LARKO** 26-46×24,5 mm

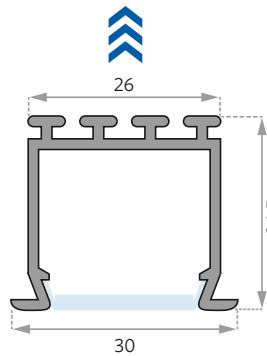

**LOKOM** 26-30×24,5 mm

## EINLEGE- UND GRUNDPROFILE | FÜR SICHTBETON/WEISSPUTZ (FIXLÄNGEN)

LAGO600-1800

30 × 35 mm

inkl. Konverterbox

Fixlängen pro Stange:

621, 921, 1221, 1521, 1821 mm

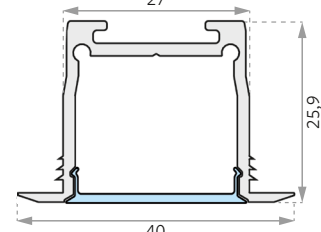
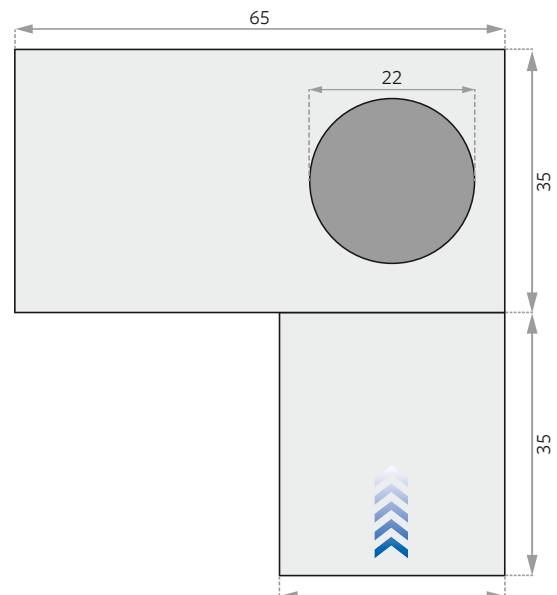

**MEDIUM WING** 40-27×25,9 mm

## EINLEGE- UND GRUNDPROFILE | HOHLDECKEN/GIPSEINBAU

### TEKNIK-ZM

30-66x28,5 mm

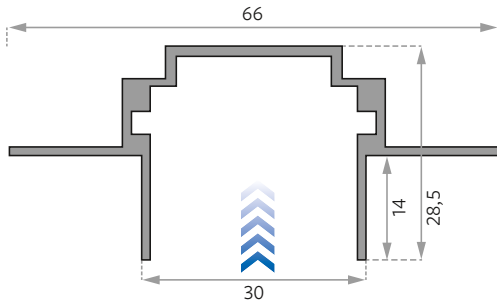

### TEKOR

30x27,8 mm

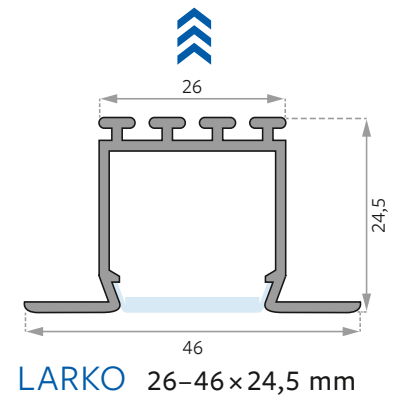
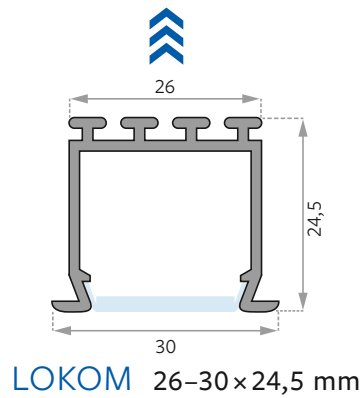
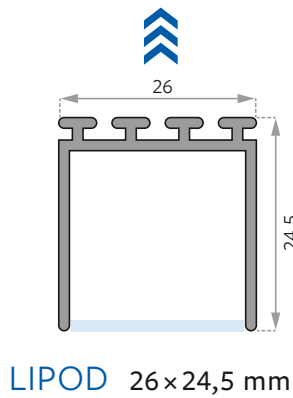
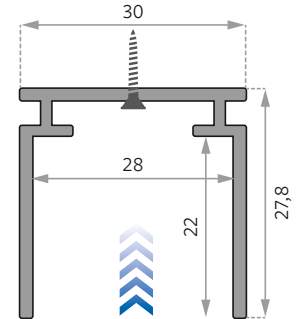

## EINLEGE- UND GRUNDPROFILE | GIPSEINBAU

### LP-U2020

20x20 mm

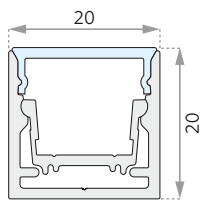

### LP-U3030

30x30 mm

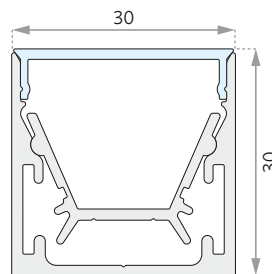

### LP-U5050

50x50 mm

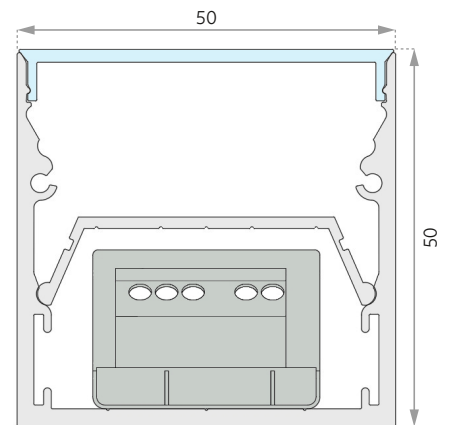

# MLT

**Moderne Licht-Technik AG**

Tägerhardstrasse 110

5430 Wettingen

056 427 02 50

[info@mlt-licht.ch](mailto:info@mlt-licht.ch)

[mlt-licht.ch](http://mlt-licht.ch)

*Gutes Licht  
ist kein Zufall*